

Lydsto Self Cleaning Sweeping Robot W2 Operating Manual

Please read this manual carefully before using the product and keep it properly

Catalog

Safety precautions

Warning	2
Attention	3

Product introduction

Main machine	4
Dust Box	5
Multi-functional cleaning base station	5

Usage of product	5
------------------------	---

Application installation and use

App connection	7
Operating instructions for switching on and off and cleaning	8
Description of cleaning base station display	9
Indicator on Clean the base station status	9

Product cleaning

Main brush disassembly and installation	10
Side brush disassembly and installation	10
Dust box and filter Removal and installation	11
Mop disassembly and installation	12
Main Machine parts Cleaning	12
Multi-functional cleaning base station cleaning	13
Multi-functional cleaning base station accessory cleaning	14

Troubleshooting	14
-----------------------	----

FAQ	16
-----------	----

Product parameter	17
Product Hazardous Substances Declaration	18
Warranty Statement	18
Warranty content	18
Product performance fault set of sweeping and mopping robot	19
Warranty card for sweeping robot products	19
Maintenance records of sweeping robot products	19

Safety precautions

Please read the manual before use

Warning: In order to avoid injury and unnecessary property loss to you and others, please read carefully and follow the following "safety precautions" before use. This section describes security precautions in two aspects: Warning and Caution. "Warning" and "Caution" are important contents for safe use and must be observed.



Warning Precautions for the risk of death or serious injury due to improper operation



Attention This section describes the precautions that may cause minor injury or damage to the product



Warning (Main machine)

1. Do not use this product in wet places such as water or nearby bathroom;
2. Do not use it to clean liquids, matches and wet garbage;
3. Do not use the unit to clean kerosene, gasoline and other flammable liquids, objects with Mars, toner and other flammable dust, or use the unit near the above items and flammable and explosive gas to prevent it from fire;
4. Except for the replacement of consumables according to this manual, do not disassemble, repair or transform by yourself, in order to avoid fire, injury or poor operation;
5. If main brush is found not good working during use, please turn off the switch button and immediately check whether the rolling brush is wrapped with hair or other excessively long fibers and clean it in time;
6. The battery is a sealed device, and there is no potential safety hazard under normal conditions. If the liquid flows out of the battery under extreme conditions, it may cause irritation or burns. In case of eye contact, flush immediately under running water for at least 15 minutes and seek medical help immediately;
7. The device is not suitable for children or people with poor physical, sensory and mental health and lack of experience and knowledge. Please use it under supervision;
8. Please keep the sweeping robot away from the electromagnetic equipment of the hospital; Supervise children not to play with the product; The sweep and tow robot can only be used with the provided cleaning base station;
9. The battery must be removed from the machine before it is abandoned; When removing the battery, the machine must be powered off; Remove the screws from the bottom cover, open the bottom cover, and remove the battery connection terminals. Remove the battery from the battery box. Recycle the used battery pack;
10. It is recommended to charge it once a month if it is not used for a long time.



Warning (Cleaning base Station)

1. Do not pull and insert the plug with wet hands;
2. Do not use damaged power plugs or loose sockets;
3. When cleaning the base station, please use the rated voltage AC power supply, do not use the generator or DC power supply, etc., to avoid fire and electric shock;

4. Clean the dust on the plug regularly with dry cloth to avoid fire caused by poor insulation;
5. Be sure to insert the plug to the end to avoid electric shock, short circuit and fire;
6. In case of abnormal fault, please immediately cut off the power supply and stop using it to avoid smoke, fire and electric shock;
7. When the product is being charged or used, there is abnormal heating and deformation of the body , burning smell and abnormal sound in operation. Please immediately cut off the power and unplug the plug. Place the product in the open and near without combustibles to ensure safety and be replaced and repaired by the manufacturer or its professional maintenance personnel to avoid danger;

Warning (Cleaning base Station)

8. Be sure to remove the plug from the power socket before cleaning and maintenance to avoid electric shock and injury;
9. Do not pour water on the body and plug or immerse the body and plug in water;
10. Do not use other power cords to charge the machine;
12. When unplugging the plug, please be sure to hold the insulation part of the clean base station body, and do not pull the power cord;
13. If the shell is damaged, do not use the clean base station to avoid the danger of electric shock;
14. This cleaning base station is only applicable to the sweeper robot designated by the merchant;
15. Before charging, check whether the specification information of cleaning base station is consistent with the required power supply voltage;

Attention (Main machine /clean base station)

1. Do not use this product outdoors, off-ground, commercial or industrial environment;
2. Do not use it in a hanging environment without a guardrail;
3. Do not block the exhaust port (in order to avoid deformation, failure or fire caused by overheating);
4. Do not drag the machine (so as not to scratch the ground);
5. Do not wave the machine or let children play with the machine (in order to avoid injury or damage to the machine);
6. Do not fall off the machine, hit other objects, and apply pressure to the machine (to avoid fire and electric shock accidents caused by failure);
7. Please be sure to install the main brush and filter element before use (in order to avoid affecting the cleaning performance of the machine);
8. Please check whether the clean base station charging line is in good condition before charging;
9. Before using the product, please place the furniture, furniture and floor items neatly, and clean the power cord and small items on the ground to avoid obstruction in cleaning;
10. When the machine is running, keep the carpet smooth so as not to obstruct the products in operation;
11. Do not stand in front of robot when the it is running. Otherwise, robot cannot identify the area to be cleared;
12. Do not use or store the body under extreme adverse conditions, such as extreme temperature, etc. It is recommended to use it indoor with ambient temperature, and store it in a cool and dry place.

Product introduction

Main machine

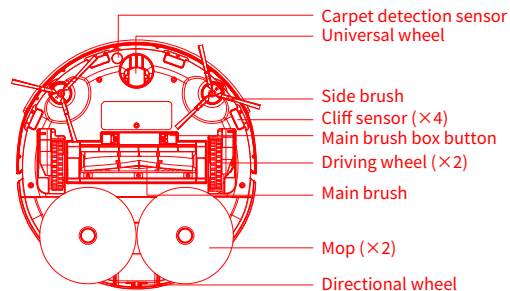
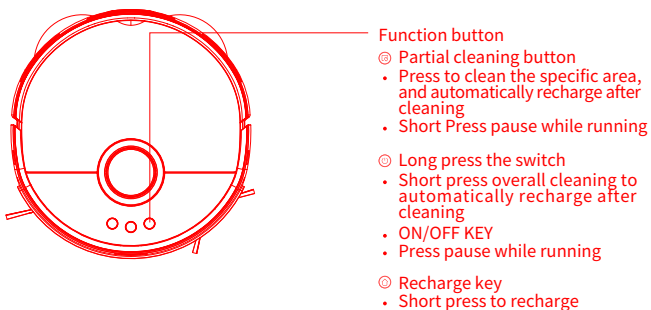
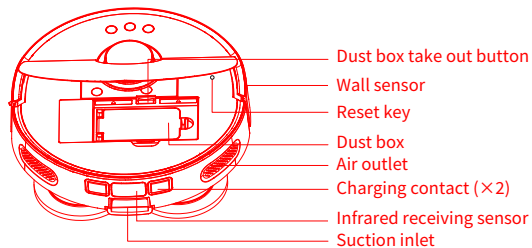
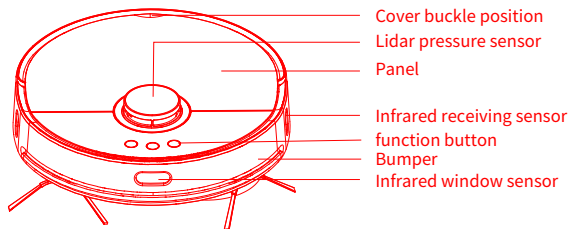

Dust Box

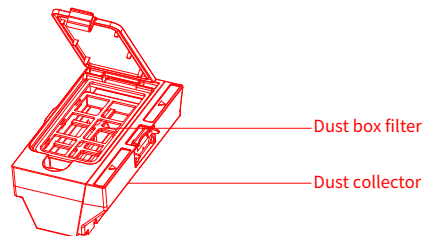
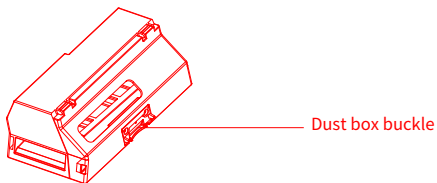

Multi-functional cleaning base station

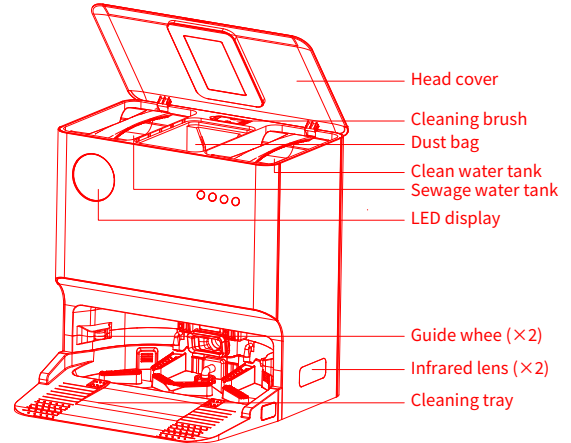
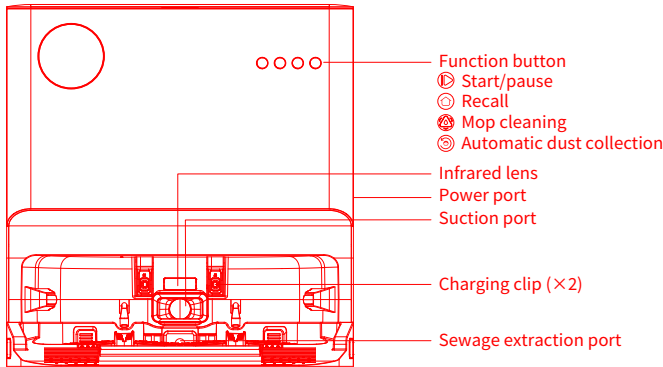

Usage of product

Step 1: Remove the limiter strips on both sides of the bumper;

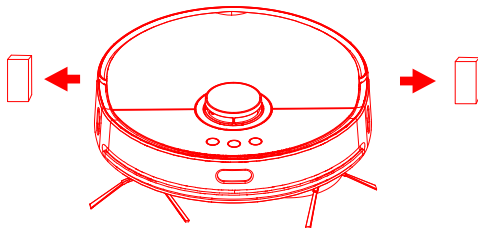

Step 2: paste the mop in the mop support paste area, the mop support assembly limit into the bottom groove;

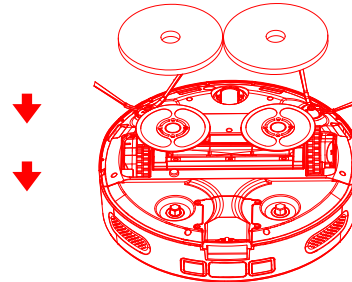

Step 3: Find a suitable place to place the cleaning base station, and ensure that the cleaning base station is placed horizontally;

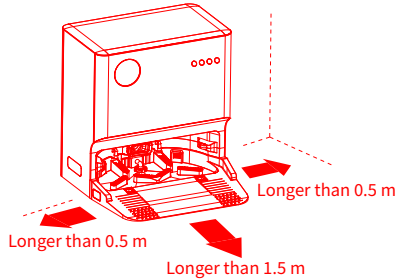

Step 4: Take out the clean water tank, remove the cover of the clean water tank, put the clean water tank after water injection (the water amount is lower than MAX line) back to the cleaning base station, and cover the top cover of the cleaning base station;

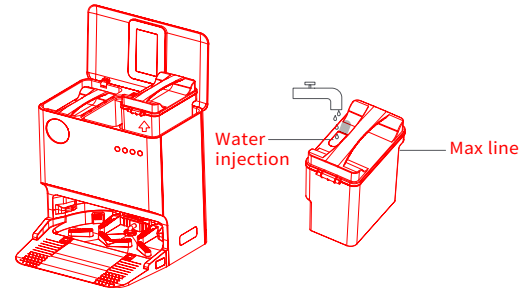

Step 5: Clean the base station as shown in the picture below. Connect the power and pair the robot with the base station. The robot needs to be pressed "On/off key + partial cleaning key" for 5 Seconds, and the base station needs to be pressed the "On/off key " for 5 Seconds. You will have 1 minute to pair. After successful pairing, the mainframe is placed on the base station for charging.

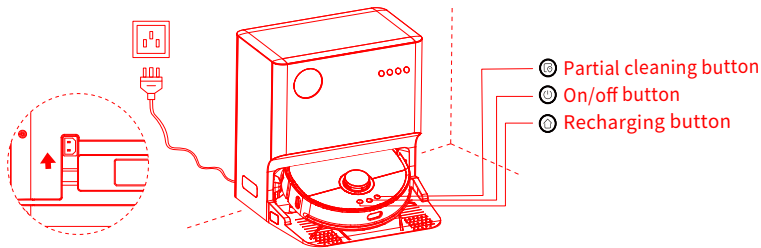

Attention

1. Avoid using this product in the room of infants and pets, and keep away from infants and pets to avoid danger;
2. In order to facilitate the robot to return to the cleaning base station after cleaning, it is recommended that the robot start from the cleaning base station and do not move the cleaning base station during cleaning;
3. The cleaning base station has the functions of collecting dust, charging, cleaning mop and air drying mop. A new dust bag has been installed before packing;
4. Do not use the mop on the carpet.



Application installation and use

Connect to MIJIA APP

The product has been connected to MIJIA. It can be controlled by MIJIA APP and interconnected with other products. Scan the QR code, download and install MIJIA APP. Users with MIJIA APP already installed will directly enter device connection page. Or search "MIJIA" in APP store, download and install MIJIA APP. Open the home page of MIJIA APP, click "+" at the top right, and add the device according to the method recommended by the APP. Note: The actual operation may be slightly different from the description above due to the upgrade and update of MIJIA APP. Please follow the current guide in MIJIA APP.



Reset Wi Fi

Press  button and  button for 3 seconds at the same time, and hear the sound prompt "Wi-Fi has been reset". The power indicator flash in blue. At this time, hold them on for 2 seconds. Hear the sound prompt "Enter MIJIA Networking Mode", then enter the MIJIA Networking Mode. After that, use MIJIA APP for networking operations.



Connect to Lydsto APP

Lydsto APP can be downloaded from Apple APP market or Google APP market.

Or Scan the following QR code, Download and install Lydsto APP.



Reset Wi Fi

Press and hold the buttons  and  for 3 seconds, then you will hear a voice prompt "Wi Fi has been reset", the power indicator will blink in blue, and the sweeping and mopping robot will enter the state of waiting connection. Tips: only 2.4GHz frequency band Wi Fi network is supported.

Operating instructions for switching on and off and cleaning

1. Power on/off

Power on: Long press the switch button, switch button indicator light up, the robot into standby state;

Shutdown: Long press the switch button, the indicator light slowly extinguished and shutdown;

2. Charging

After cleaning, robot will automatically return to the cleaning base station and recharge;

If robot does not start cleaning from the cleaning base station, the recharge function may fail. You need to manually place it on the cleaning base station; When robot is charging, the recharging light is blinking slowly, and the on-off indicator is steady on after it is fully charged,

3. Overall cleaning

After the first cleaning, it will scan and partition into an intelligent map, and clean along the wall firstly then zigzagging shape, after the cleaning will automatically return to the cleaning base station;

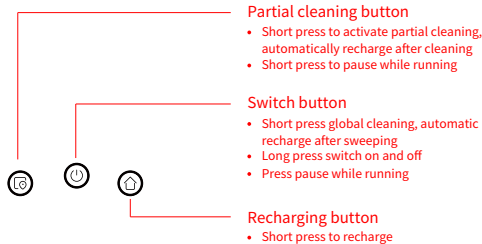

4. Partial cleaning

When robot is in standby or suspended, press the Partial cleaning button to start partial cleaning. The cleaning area is a square area 1.6m X 1.6m with the robot as the center. After the cleaning, it automatically returns to the starting position and stops working;

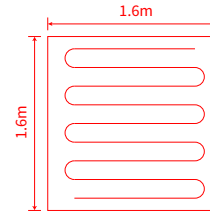

Partial cleaning

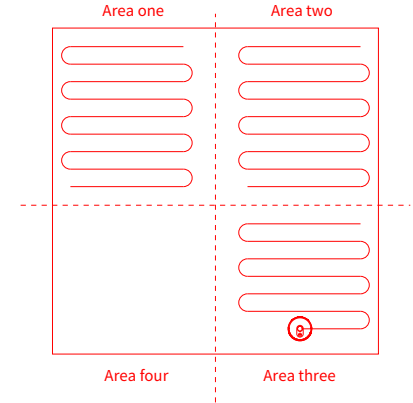

5. Fault performance

When the running status of robot is abnormal, the button indicator of the switch will have flash in red and voice reminder. Please refer to this manual for troubleshooting and get rid of the problems.

6. Hibernate

When the running status of robot is abnormal, the button indicator of the switch will flash red and voice will be announced. Please refer to this manual for troubleshooting and solving abnormal problems.

7. Automatic dust collection

After cleaning, it will automatically return to cleaning base station for dust collection

8. The reset button

When the button does not respond or cannot be turned on, please try to reset the system, press the reset button (see page 4 for details), robot will automatically restart; The reset will clear robot periodic cleaning Settings and cleaning mode Settings and reset WiFi.

Attention

1. It is recommended to place the robot in the charging position of the cleaning base station to start cleaning;
2. When the power is insufficient during the cleaning process, the robot will automatically return to the cleaning base station for charging, and resume to continue cleaning after sufficient power is added;
3. Before using the product, please place furniture and floor items neatly, and clean the power cord and small items on the ground to avoid obstruction in cleaning;
4. Do not stand in front of the machine when it is running, in case the it cannot identify the area to be cleaned;

Description of Multi-functional cleaning base station display

Power on the cleaning base , the display screen is steady on, if there is no operations with the base or 60 seconds, and the screen goes off.

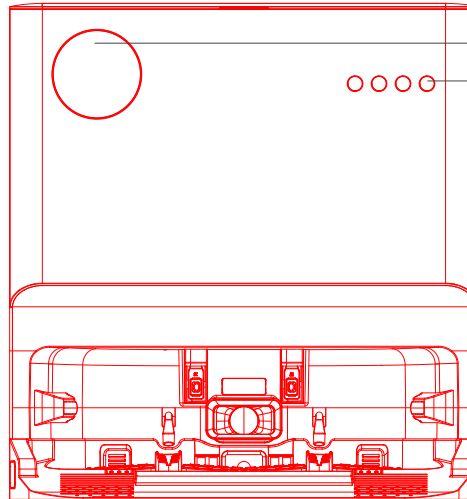

Led display





Function button

 Start/pause

 Recall

 Mop cleaning

 Automatic dust collection

 Start/pause	Start: Execute the task. Pause: Suspend the task;
 Recall	Sweep and mop / single mop: when robot is in the base station, short press to maintain the current charging state;When it is not in the base station, short press the short button to recall it to the base station, collect dust (more than 1 minute), clean the mop, dry and charge;Single sweep: when robot is in the base station, press to maintain the current charging state;When robot is not in the base station, press to recall it to the base station, dust collection (more than 1 minute), charge;
 Mop-cleaning	Sweep and single mop: when robot is in the base station, short press cleaning mop, drying, charging;When robot is not in the base station, short press to display that robot is not on the base station.Single sweep: when robot is in the base station, short press has no effect;When robot is not in the base station, the short press has no effect and the robot is not in the base station.
 Automatic dust collection	Short press to dust collecting for 12 seconds

* Tip: Finger touch button to start

Product disassembly and cleaning

Please carry out the following cleaning steps in the case of power off!

Disassembly and installation of main brush assembly

Step 1: Main brush disassembly

Turn over the machine, hold the release button of the roller brush box and move to the center respectively, remove the outer cover of the main body; Remove the main brush, clean the surface attachment.

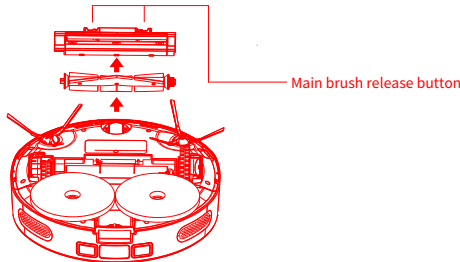

Step 2: Main Brush cleaning

Use a cleaning brush to lift and cut off the hair and fiber material attached to the main brush, and separate it from brush. It is recommended to replace the main brush every 3-6 months.

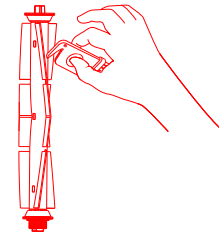

Side brush disassembly and install

Step 1: Remove the side brush

Turn over the machine, unscrew the screw with a screwdriver, and remove the side brush.

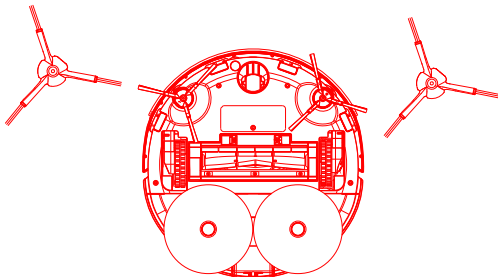

Step 2: Side brush cleaning

Use clean brush to brush on the side of the attached hair and fiber material to stir up and cut off, so that it and the side of the brush from; it is recommended to replace the side brush every 3-6 months to ensure the cleaning effect.

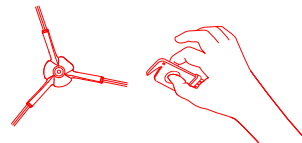

Attention

1. Please replace the side brush configured by the original factory to ensure the cleaning effect;
2. Replace the edge brush with a screwdriver to avoid scratches;
3. Due to a sharp blade in clean knife, please keep it out of the touch of children.

Disassembly and installation of dust box and filter assembly

Step 1: Dust box disassembly

Open the upper cover upward, press the dust box button, take out the dust box;

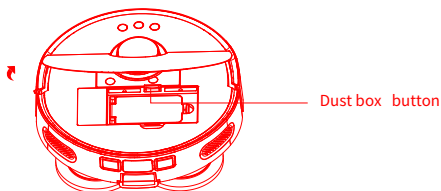

Step 3: Filter element disassembly

Users decide whether to clean the filter element according to their own use. If cleaning is needed, please remove the filter element support according to the order shown in the picture, take out the filter element, clean it with cleaning tools and then install it back in the original order, or replace it with a new filter element;

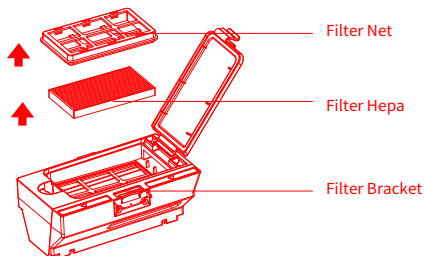

Step 2: Dump the dust box garbage

Open the dust box release buckle, aim the dust box at the garbage can, dump dust, the cleaning brush can help to clean the corner which is hard to reach can be cleaned with a cleaning brush;



Step 4: Clean the dust box

Rinse the dust box/filter element with clean water, and dry it, so that dust clumping and unpleasant smell will not appear then.

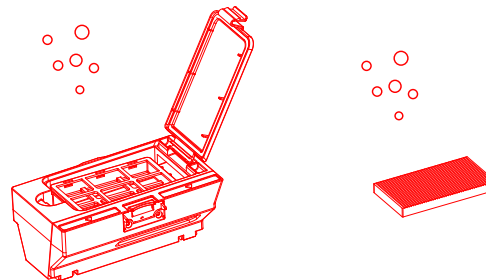

Mop disassembly and installation

Step 1: mop removal

Remove the mop module from the chassis and remove the mop cloth from the mop bracket;

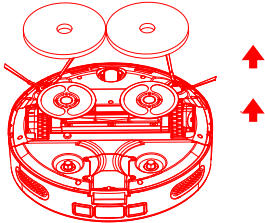

Step 2: mop cleaning

Rinse the mop with clean water and dry it to prevent dust clumping and unpleasant smell when it is used again.

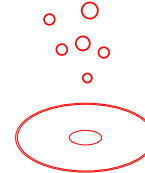

⚠ Attention

1. Please replace the mopping cloth configured by the original factory, so that the cleaning effect of the main engine will not be affected because of different products;
2. Please be sure to remove the mop and clean it to avoid dirty water pouring back;
3. It is recommended to replace the original mopping cloth every 3-6 months to ensure the cleaning effect.

Cleaning of main engine parts

Step 1: Clear the sensor on the robot

Clean the charging contact, cliff sensor, lidar pressure sensor, infrared sensor and wall sensor on the back of the robot with a soft and clean cloth;

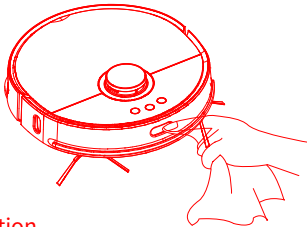

⚠ Attention

1. Use dry rags to clean the robot sensor, infrared sensor, and charging contact to prevent damage caused by water.
2. Replace the parts with a screwdriver to avoid damage.

Step 2: Clean the universal wheel

Pull out the universal wheel upward and clean the hair and dirt on the wheel body and axle. The universal wheel can be washed and reused after drying.

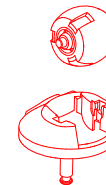

Multi-functional cleaning base station cleaning

Step 1: Dust bag replacement

When the dust bag is full, replace the dust bag as prompted by the base station display screen. It is recommended to replace the dust bag every 4 weeks;



Step 2: Clean the dust path

In the state of power off, check whether there is any abnormal blockage between the transparent dust path and the dust inlet. If there is any, please clean out it in time;

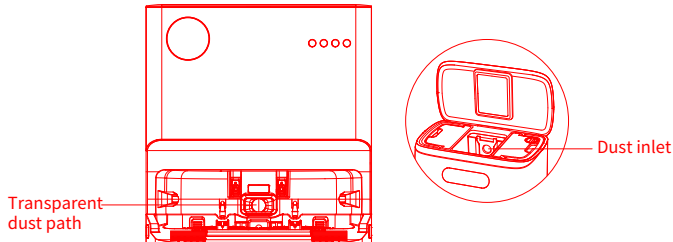

Step 3: Clean the infrared lens and charge the shrapnel

Clean the infrared lens and charge shrapnel with a soft and clean cloth to ensure that there is no debris.

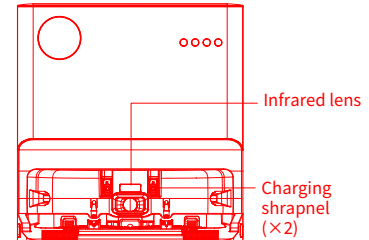

Multi-functional cleaning base station parts

Step 1: Clean the sewage tank

Open the top cover of the cleaning base station, take out the sewage tank, open the sewage tank to release the buckle, clean the dirt in the water tank with a long cleaning brush, and put it back to the cleaning base station after cleaning.

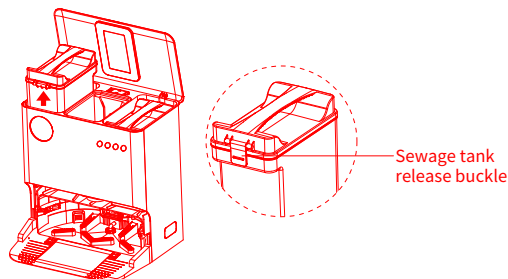

Step 2: Clean the tray base

Take out the tray base and use a cleaning brush to clean up the dirt, and then install it back to the base station.

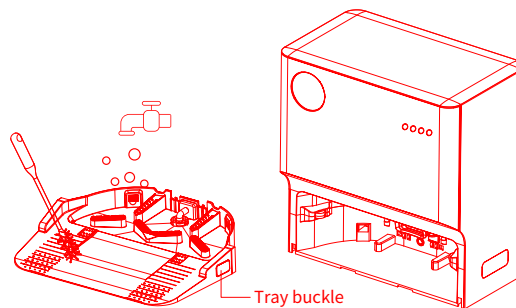

Troubleshooting

When something abnormal occurs during the operation of the sweep and mop robot, the key indicator will blink quickly and voice prompt will be given. The following methods will be used to help to remove the fault. If the fault cannot be removed, please contact the after-sales service.

Fault phenomenon(robot)	Solution
Error 1: Check if the radar is blocked and move to a new position to start or check if the radar is stuck	Check whether the radar is blocked or blocked by any foreign object. Remove any blockage or foreign object
	Please do not use in strong light
	If above methods do not work, move robot to a new location to start
Error 2: Check whether the bumper is stuck	Please check whether the bumper is stuck by debris, remove debris, and repeatedly tap the bumper, check whether flexible
	Please check whether the machine is trapped because running space is too small, please move to a new position to start
Error 3: Please wipe the cliff sensor and start away from the danger area	Check whether robot is suspended and move it to a new position to start
	Check whether the cliff sensor is dirty and blocked by dust and other debris. Cliff sensor is suggested to be cleaned periodically

Error 4: Check whether the main brush is stuck	Please check whether the main brush is entangled with wool, wires and other sundries. Please remove the main brush and clean it
	Please check whether there are any tangled objects such as wool and electric wires on the indoor floor and clean them up
	The main brush is a sticky part that needs to be cleaned regularly
Error 5: Check if the side brush is stuck	Please check whether the side brush is entangled with wool, wire and other sundries. Please remove the bottom brush and clean it
	Please check whether there are any tangled objects such as wool and electric wires on the indoor floor and clean them up
	Side brushes are tangled parts that need to be cleaned regularly
Error 6: Check whether the main wheel is stuck	Please check whether there is any debris stuck in the wheel and remove it
Error 7: Please return the dust box	Please reinstall the dust box and confirm that the filter screen and dust box are installed properly
	If errors are reported after installation, please try to replace the filter
Error 8: Low battery, please charge	The battery is low, please charge it and use it again
Error 9: The charging fails. Check whether the connection between the robot and the base station is normal	Please wipe the charging contact of the main engine and the base station charging shrapnel with a dry cloth
Error 10: The battery temperature is abnormal. Try again later	If the battery temperature is too high or too low, wait until the battery temperature becomes normal
Error 11: Check the right side wall sensor	The wall sensor is blocked by dust. Wipe the wall sensor on the right
Error 12: Please start machine on level ground	Detected machine tilt during startup, please restart machine on level ground
Error 13: The scavenging fan is abnormal	The suction fan cannot work properly, reset the system
Error 14: Clean the filter	Please remove the filter assembly from the machine for cleaning

Fault phenomenon(base station)	Solution
Error 1: Recharge failed. Please clear the obstruction near the base station	Please clear the obstacles near the base station and make sure there are no obstacles 1.5 meters in front of the base station
Error 2: Restart away from the restricted area	Please move the machine away from the software virtual wall or restricted area and restart it.
Error 3: Check whether the mop assembly is stuck	Please check whether there are sundries wrapped and blocked in the mopping component, and remove them.
Error 4: Please reinstall clean water tank	Check whether the clean water tank is in place or properly installed.
Error 5: No water in the clean tank	Please check the clean tank and fill it up to the MAX line of the clean tank
Error 6: Please reinstall the sewage tank	Check whether the sewage tank is in place or properly installed
Error 7: Sewage tank is full	Please clean the sewage water tank and reinstall the sewage water tank
Error 8: Sewage tank is abnormal	Please check that the sewage tank's cover is properly closed
	Check that the sewage tank is properly installed
	Check whether the drainage vent is blocked and clean the drainage vent regularly

Error 9: Please load the cleaning tray	Check whether the cleaning tray is in place or properly installed, and reinstall the cleaning tray
Error 10: Dust bag not in place, please check	Check whether dust bags are installed
	If dust bags have been installed, check whether the dust bags are inserted to the bottom
Error 11: Base station wind pressure is abnormal	Please check that the base station roof is properly closed
	Please check whether the dust bag is full and replace it in time
Error 12: Dust bag is full	If the dust bag is not full, check whether the dust path of the base station is blocked. If the dust path of the base station is blocked, try to manually clean the dust path
Error 13: Dust collection is abnormal	Please check whether there is any foreign matter in the dust collecting port of the base station dust bag and clean the foreign matter in the dust collecting port
	Please check whether the dust box is blocked and clean the dust box
Error 14: Standby	When you return to the base station in mopping state, the net water tank is not in place or enters standby without water
	When the sewage tank is not in place or when the water is full and the base station is returned to the standby state, the sewage tank is not replaced
	When returning to the base station in mop state, the cleaning tray is not in position and enters standby
	When returning to the base station, the cleaning tank is full of water and enters standby mode

Tip: Resetting the system can eliminate some faults.

FAQ

Types of problem	Solution
Unable to start	Battery power is low, please rely on the base station to charge before using; if the battery temperature is too low or too high, use the battery at an environment of 0 °C to 40 °C
Unable to charge	The base station is not energized, please confirm whether both ends of the power line of the base station have been plugged; Poor contact, please clean the base station shrapnel and robot charging contact; Make sure the base station display screen is lit up
Slow charging	In high or low temperature environment, in order to prolong the service life of the battery, the main machine will automatically reduce the charging speed; The charging contact area may be dirty. Clean the area with a dry cloth
Unable to recharge	There are too many obstacles near the base station. Please place the base station in an open area. Robot is too far from the base station, please try to place robot near the base station
There is an abnormal sound when cleaning	The main brush, side brush or main wheel may be wrapped with foreign matter, please stop the machine and clean it; Use a screwdriver to pry out and clean the universal wheel if it is contaminated or wound
Unable to connect WiFi	WiFi is not activated, please reset the WiFi and try again
	WiFi signal is not good, please ensure that robot is in a good WiFi signal coverage area
	If the WiFi connection is abnormal, reset the WiFi and download the latest mobile app to try reconnect
	APP does not support the current device model. Check the supported model as prompted
	WiFi suddenly fails to be connected. It is suspected that the home router is incorrectly set. Please contact the after-sales service

Types of problem	Solution
Does it need to be recharged for 16 hours for the first three uses	Lithium battery has no memory effect,use it when it is full
During the cleaning, the power is insufficient and the cleaning is not continued	Ensure that the robot is not in do not disturb mode, which does not continue scanning.Manual charging or putting robot back to the base station does not continue scanning
Unable to return to base station after partial cleaning or moving position	The robot will regenerate the map after partial cleaning or long-distance position movement. If the base station is far away, it may not be able to recharge automatically. Please manually put the robot back to the base station for charging
The scanning robot has missed scanning	The sensor along the wall or cliff is dirty. Use a soft dry cloth to clean the sensor
Decline in cleaning capacity	Dust box is full, please clean the dust box;The filter has been blocked, please clean the filter screen;The main brush is wrapped with foreign matter. Please clean the main brush
Regular cleaning does not take effect	Scheduled cleaning will be started only when the remaining power is more than 15%
Whether the base station consumes power constantly	When the machine has been in the base station, the power consumption is very low, which helps to keep the battery in the best performance

Basic parameter

Product name	Lydsto Self Cleaning Sweeping Robot W2	Model	YM-W2-B03、YM-W2-W03
Working voltage	DC24V	Rated power	50W
Charge current	1A	Battery capacity	5200mAh
Net weight	4.15kg	Product size	354*354*98.5mm
Charging time	About 250 mins	Noise	<70dB(A)
Capacity of dust collector	350mL		

Product name	Multi-functional cleaning base station	Model	JCB-W2-B03、JCB-W2-W03
Rated power	1000W	Rated input	230V~ 50Hz
Rated voltage	24V=3A	Product size	430*430*455mm
Net weight	10.55kg	Noise	<80dB(A)
Dust collecting time	12S	Capacity of dust bag	3L

Device requirements: devices supporting Android 5.0 or iOS 10 or later (iPhone 5 or later)

Manufacturer: Guangdong Yimu Technology Co., Ltd.
Service number: +86-400-077-8387

Address: Room 201, Building 1, No.1, Dongsan Lane, Hengjiang, Fushan, Liaobu Town, Dongguan, Guangdong, China

FCC Statement

This device complies with Part 15 of the FCC Rules. Operation is subject to the following two conditions:

(1) This device may not cause harmful interference.

(2) This device must accept any interference received, including interference that may cause undesired operation.

2. Changes or modifications not expressly approved by the party responsible for compliance could void the user's authority to operate the equipment.

Note: This equipment has been tested and found to comply with the limits for a class B digital device, pursuant to Part 15 of the FCC Rules. These limits are designed to provide reasonable protection against harmful interference in a residential installation.

This equipment generates uses and can radiate radio frequency energy and, if not installed and used in accordance with the instructions, may cause harmful interference to radio communications. However, there is no guarantee that interference will not occur in a particular installation. If this equipment does cause harmful interference to radio or television reception, which can be determined by turning the equipment off and on, the user is encouraged to try to correct the interference by one or more of the following measures:

- Reorient or relocate the receiving antenna.
- Increase the separation between the equipment and receiver.
- Connect the equipment into an outlet on a circuit different from that to which the receiver is connected.
- Consult the dealer or an experienced radio/TV technician for help.