

Ronix®

Premium Quality

20V BRUSHLESS HAMMER DRILL DRIVER

8900

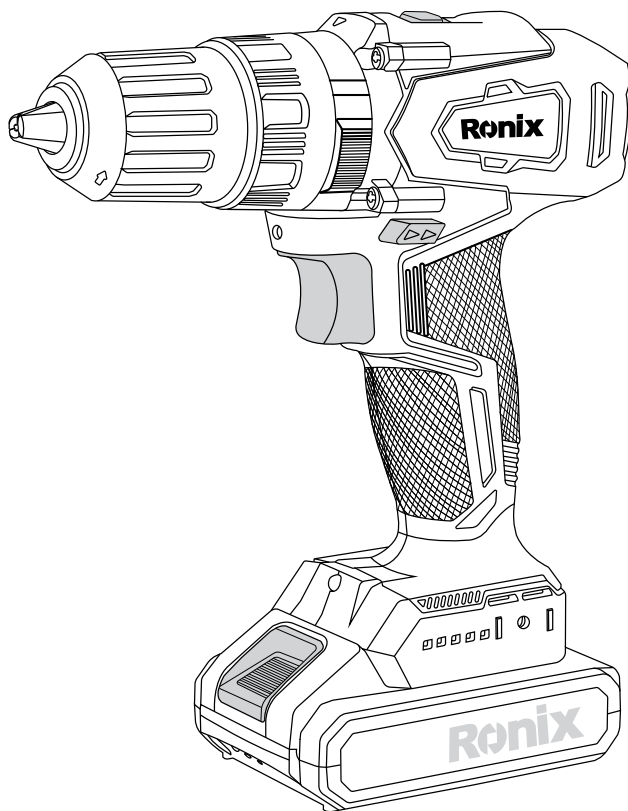

www.ronixtools.com

12
MONTHS
GUARANTY

FREE
DELIVERY

BANK
SPARE PARTS

CALL
CENTER
02161904

TECHNICAL SPECIFICATIONS

Model	8900
Rated voltage	20V
Max. torque	45Nm
Impact rate	0-25500bpm
No Load speed	0-450/0-1700rpm
Chuck capacity	2 to13mm
Torque setting	21+3
accessories	No Battery and chargers

USABLE BATTERIES FOR 8900

Ronix Model No.	Product
8990	20V battery pack, 2.0Ah Li-ion battery
8991	20V battery pack, 4.0Ah Li-ion battery

USABLE CHARGERS FOR 8900

Ronix Model No.	Product
8992	20V fast charger, Output:22V 2.2A
8993	20V fast charger, Output:22V 4.5A
8994	20V fast charger, Output:22V 4.5A (Dual Model)

PART LIST

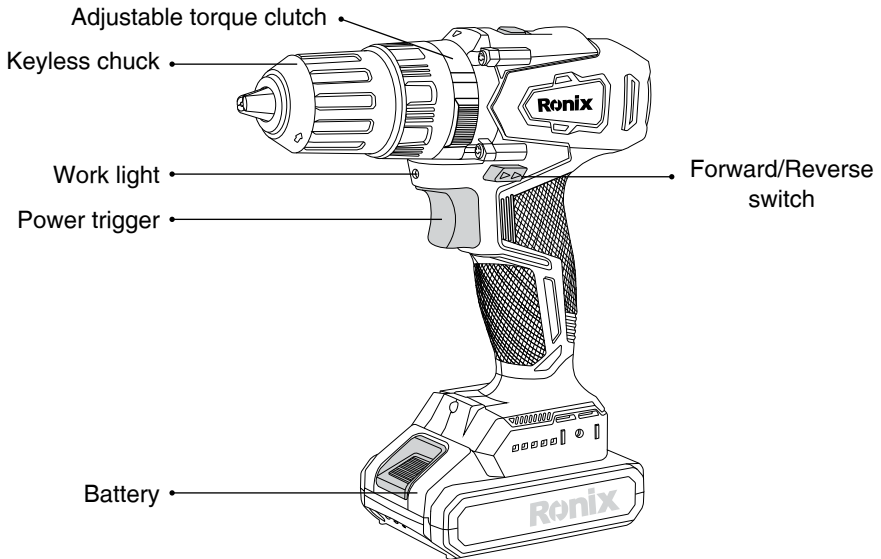

GENERAL POWER TOOL SAFETY RULES

⚠ WARNING!

- Read all safety warnings and all instructions. Failure to follow the warnings and instructions may result in electric shock, fire and/or serious injury.
- Save all warnings and instructions for future reference.
- The term «power tool» in the warnings refers to your mains-operated (corded) power tool or battery-operated (cordless) power tool.

■ WORK AREA SAFETY

- Keep work area clean and well lit. Cluttered or dark areas invite accidents.
- Do not operate power tools in explosive atmospheres, such as in the presence of flammable liquids, gases or dust. Power tools create sparks which may ignite the dust or fumes.
- Keep children and bystanders away while operating a power tool. Distractions can cause you to lose control.

■ ELECTRICAL SAFETY

- Power tool plugs must match the outlet. Never modify the plug in any way. Do not use any adapter plugs with earthed (grounded) power tools. Unmodified plugs and matching outlets will reduce risk of electric shock.
- Avoid body contact with earthed or grounded surfaces such as pipes, radiators, ranges and refrigerators. There is an increased risk of electric shock if your body is earthed or grounded.
- Do not expose power tools to rain or wet conditions. Water entering a power tool will increase the risk of electric shock.
- If operating a power tool in a damp location is unavoidable, use a ground fault circuit interrupter (GFCI) protected supply. Use of a GFCI reduces the risk of electric shock.

■ PERSONAL SAFETY

- Stay alert, watch what you are doing and use common sense when operating a power tool. Do not use a power tool while you are tired or under the influence of drugs, alcohol or medication. A moment of inattention while operating power tools may result in serious personal injury.
- Use personal protective equipment. Always wear eye protection. Protective equipment such as dust mask, non-skid safety shoes, hard hat, or hearing protection used for appropriate conditions will reduce personal injuries.
- Prevent unintentional starting. Ensure the switch is in the off-position before connecting to power source and/or battery pack, picking up or carrying the tool. Carrying power tools with your finger on the switch or energizing power tools that have the switch on invites accidents.
- Remove any adjusting key or wrench before turning the power tool on. A wrench or a key left attached to a rotating part of the power tool may result in personal injury.
- Do not overreach. Keep proper footing and balance at all times. This enables better control of the power tool in unexpected situations.
- Dress properly. Do not wear loose clothing or jewelry. Keep your hair, clothing, and gloves away from moving parts. Loose clothes, jewelry or

long hair can be caught in moving parts.

-If devices are provided for the connection of dust extraction and collection facilities, ensure these are connected and properly used. Use of dust collection can reduce dust-related hazards.

■ POWER TOOL USE AND CARE

-Do not force the power tool. Use the correct power tool for your application. The correct power tool will do the job better and safer at the rate for which it was designed.

-Do not use the power tool if the switch does not turn it on and off. Any power tool that cannot be controlled with the switch is dangerous and must be repaired.

-Disconnect the plug from the power source and/or the battery pack from the power tool before making any adjustments, changing accessories, or storing power tools. Such preventive safety measures reduce the risk of starting the power tool accidentally.

-Store idle power tools out of the reach of children and do not allow persons unfamiliar with the power tool or these instructions to operate the power tool. Power tools are dangerous in the hands of untrained users.

-Maintain power tools. Check for misalignment or binding of moving parts, breakage of parts and any other condition that may affect the power tool's operation. If damaged, have the power tool repaired before use. Many accidents are caused by poorly maintained power tools.

-Keep cutting tools sharp and clean. Properly maintained cutting tools with sharp cutting edges are less likely to bind and are easier to control.

-Use the power tool, accessories and tool bits etc. in accordance with these instructions, taking into account the working conditions and the work to be performed. Use of the power tool for operations different from those intended could result in a hazardous situation.

■ BATTERY TOOL USE AND CARE

-Recharge only with the charger specified by the manufacturer. A

charger that is suitable for one type of battery pack may create a risk of fire when used with another battery pack.

-Use power tools only with specifically designated battery packs. Use of any other battery packs may create a risk of injury and fire.

-When battery pack is not in use, keep it away from other metal objects, like paper clips, coins, keys, nails, screws or other small metal objects that can make a connection from one terminal to another. Shorting the battery terminals together may cause burns or a fire.

-Under abusive conditions, liquid may be ejected from the battery; avoid contact. If contact accidentally occurs, flush with water. If liquid contacts eyes, additionally seek medical help. Liquid ejected from the battery may cause irritation or burns.

■ SERVICE

-Have your power tool serviced by a qualified repair person using only identical replacement parts. This will ensure that the safety of the power tool is maintained.

-Follow instruction for lubricating and changing accessories.

-Keep handles dry, clean and free from oil and grease.

CORDLESS DRILL/SCREW DRIVER SAFETY

WARNING!

-Hold power tool by insulated gripping surfaces, when performing an operation where the fastener may contact hidden wiring or its own cord. Fasteners contacting a «live» wire may make exposed metal parts of the power tool live and could give the operator an electric shock.

-Always be sure you have a firm footing. Be sure no one is below when using the tool in high locations.

-Hold the tool firmly.

-Keep hands away from rotating parts.

-Do not leave the tool running. Operate the tool only when hand-held.

-Do not touch the drill bit or the work piece immediately after operation;

they may be extremely hot and could burn your skin.

-Some material contains chemicals which may be toxic. Take caution to prevent dust inhalation and skin contact. Follow material supplier safety data.

 **WARNING!**

Do not let comfort or familiarity with product (gained from repeated use) replace strict adherence to safety rules for the subject product. Misuse or failure to follow the safety rules stated in this instruction manual may cause serious personal injury.

IMPORTANT SAFETY INSTRUCTIONS FOR BATTERY CARTRIDGE

-Before using battery cartridge, read all instructions and cautionary markings on (1) battery charger, (2) battery, and (3) product using battery.

-Do not disassemble battery cartridge.

-If operating time has become excessively shorter, stop operating immediately. It may result in a risk of overheating, possible burns and even an explosion.

-If electrolyte gets into your eyes, rinse them out with clear water and seek medical attention right away. It may result in loss of your eyesight.

 **DO NOT SHORT THE BATTERY CARTRIDGE**

1. Do not touch the terminals with any conductive material.

2. Avoid storing battery cartridge in a container with other metal objects such as nails, coins, etc.

3. Do not expose battery cartridge to water or rain. A battery short can cause a large current flow, overheating, possible burns and even a breakdown.

-Do not store the tool and battery cartridge in locations where the temperature may reach or exceed 500 C (1220 F).

-Do not incinerate the battery cartridge even if it is severely damaged or is completely worn out. The battery cartridge can explode in a fire.

-Be careful not to drop or strike battery.

-Do not use a damaged battery.

TIPS FOR MAINTAINING MAXIMUM BATTERY LIFE

-Charge the battery cartridge before completely discharged. Always stop tool operation and charge the battery cartridge when you notice less tool power.

-Never recharge a fully charged battery cartridge. Overcharging shortens the battery service life.

-Charge the battery cartridge with room temperature at 100C - 400C (500F - 1040F). Let a hot battery cartridge cool down before charging it.

LIGHTING UP THE FRONT LAMP

CAUTION:

Do not look in the light or see the source of light directly. Pull the switch trigger to light up the lamp.

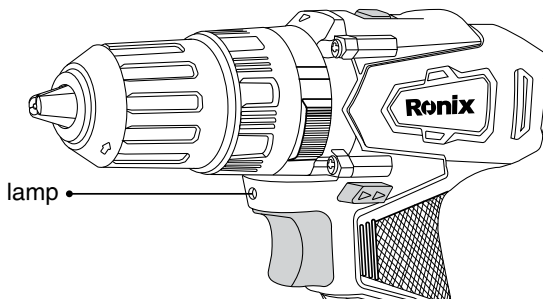

NOTE:

Use a dry cloth to wipe the dirt off the lens of lamp. Be careful not to scratch the lens of lamp, or it may lower the illumination.

REVERSING SWITCH ACTION

This tool has a reversing switch to change the direction of rotation. Depress the reversing switch lever from the Right side for clockwise

rotation or from the Left side for counterclockwise rotation. When the reversing switch lever is in the neutral position, the switch trigger cannot be pulled.

FUNCTIONAL DESCRIPTION

CAUTION:

Always be sure that the tool is switched off and the battery cartridge is removed before adjusting or checking function on the tool.

INSTALLING OR REMOVING BATTERY CARTRIDGE

-To remove the battery cartridge, withdraw it from the tool while sliding the red button on the front of the cartridge.

-To insert the battery cartridge, align the tongue on the battery cartridge with the groove in the housing and slip it into place. Always insert it all the way until it locks in place with a little click.

-Do not use force when inserting the battery cartridge. If the cartridge does not slide in easily, it is not being inserted correctly.

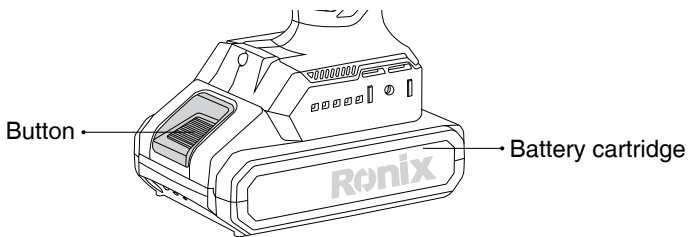

SWITCH ACTION

CAUTION:

-Before inserting the battery cartridge into the tool, always check to see that the switch trigger actuates properly and returns to the «OFF» position when released.

-Always check the direction of rotation before operation.

- Use the reversing switch only after the tool comes to a complete stop. Changing the direction of rotation before the tool stops may damage the tool.
- When not operating the tool, always set the reversing switch lever to the neutral position.

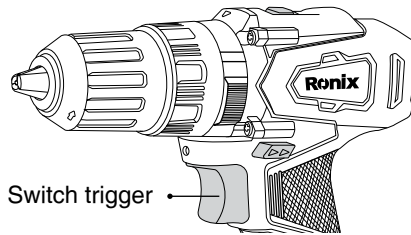

SPEED CHANGE

To change the speed, first switch off the tool and then slide the speed change lever to the «2» side for high speed or «1» side for low speed. Be sure that the speed change lever is set to the correct position before operation. Use the right speed for your job.

! CAUTION:

- Always set the speed change lever fully to the correct position. If you operate the tool with the speed change lever positioned halfway between the «1» side and «2» side, the tool may be damaged.
- Do not use the speed change lever while the tool is running. The tool may be damaged.

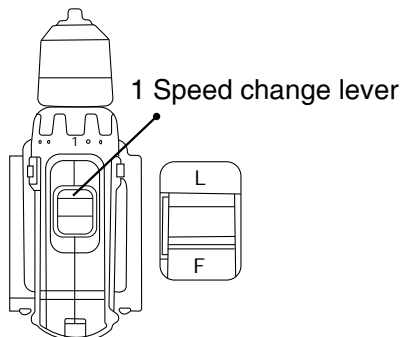

ADJUSTING THE FASTENING TORQUE

The fastening torque can be adjusted in 18 steps by turning the adjusting ring so that its graduations are aligned with the pointer on the tool body. The fastening torque is minimum when the number 1 is aligned with the pointer and maximum when the marking is aligned with the pointer.

Before actual operation, drive a trial screw into your material or a piece of duplicate material to determine which torque level is required for a particular application.

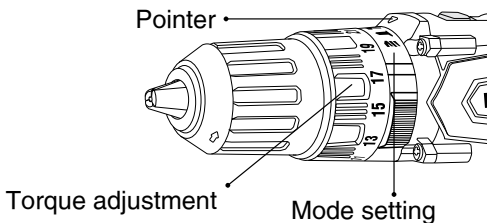

ASSEMBLY

CAUTION:

Always be sure that the tool is switched off and the battery cartridge is removed before carrying out any work on the tool.

INSTALLING OR REMOVING DRIVER BIT OR DRILL BIT

Turn the sleeve counter clockwise to open the chuck jaws. Place the bit in the chuck as far as it will go. Turn the sleeve clockwise to tighten the chuck. To remove the bit, turn the sleeve counterclockwise.

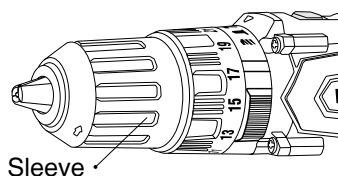

⚠ NOTE:

When driving wood screws, predrill pilot holes to make driving easier and to prevent splitting of the work piece. See the chart.

Nomina diameter of wood screw(mm)	Recommended size of pilot hole (mm)
3.1	2.0-2.2
3.5	2.2-2.5
3.8	2.5-2.8
4.5	2.9-3.2
4.8	3.1-3.4
5.1	3.3-3.6
5.5	3.7-3.9
5.8	4.0-4.2
6.1	4.2-4.4

OPERATION

⚠ CAUTION:

Always insert the battery cartridge all the way until it locks in place. If not, it may accidentally fall out of the tool, causing injury to you or someone around you. Hold the tool firmly with one hand on the grip and the other hand on the bottom of the battery cartridge to control the twisting action.

■ DRILLING OPERATION

First, turn the adjusting ring so that the pointer points to the marking. Then proceed as follows.

When drilling in wood, the best results are obtained with wood drills equipped with a guide screw. The guide screw makes drilling easier by pulling the bit into the work piece.

To prevent the bit from slipping when starting a hole, make an indentation with a center-punch and hammer at the point to be drilled. Place the

point of the bit in the indentation and start drilling. Use a cutting lubricant when drilling metals. The exceptions are iron and brass which should be drilled dry.

⚠ CAUTION:

Pressing excessively on the tool will not speed up the drilling. In fact, this excessive pressure will only serve to damage the tip of your bit, decrease the tool performance and shorten the service life of the tool.

■ SCREW DRIVING OPERATION

⚠ CAUTION:

Adjust the adjusting ring to the proper torque level for your work. Place the point of the driver bit in the screw head and apply pressure to the tool. Start the tool slowly and then increase the speed gradually. Release the switch trigger as soon as the clutch cuts in.

⚠ CAUTION:

- Make sure that the driver bit is inserted straight in the screw head, or the screw and/or bit may be damaged.
- There is a tremendous force exerted on the tool/ bit at the time of hole break through. Hold the tool firmly and exert care when the bit begins to break through the work piece.
- A stuck bit can be removed simply by setting the reversing switch to reverse rotation in order to back out. However, the tool may back out abruptly if you do not hold it firmly.
- Always secure small work pieces in a vise or similar hold-down device.
- If the tool is operated continuously until the battery cartridge has discharged, allow the tool to rest for 15 minutes before proceeding with a fresh battery.

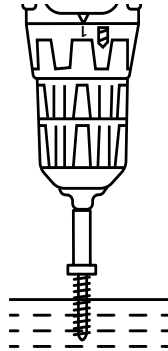

HAMMER DRILLING

For the wall drilling set the marker on the hammer mark. In this mood, the machine creates consecutive blows on the drill, which makes it easier to drill walls.

ATTENTION

Do not use the hammer mood when drilling in wood and metals.

MAINTENANCE

CAUTION:

- Always be sure that the tool is switched off and the battery cartridge is removed before attempting to perform inspection or maintenance.
- Never use gasoline, benzene, thinner, alcohol or the like. Discoloration, deformation or cracks may result.

NOTE:

To maintain product safety and reliability repairs, any other maintenance or adjustment should be performed by **Ronix Service** Authorized Service Centers, always using **RONIX** replacement parts.

Ronix[®]
Premium Quality

www.ronixtools.com