



URANUS SERIES

SOLAR FLOOD LIGHT



INTRODUCTION

Product specifications

01	FRONT COVER	02	CATALOG	03 ~ 04	MAIN ADVANTAGES
05	SPECIFICATIONS	06	OPTICAL FIGURE	7	DIMENTION FIGURE
8	DIMENTION FIGURE	9	MORE DETAILS	10	CORE TECHNOLOGY
11 ~ 12	PACKAGE DETAIL	13	APPLICATION		

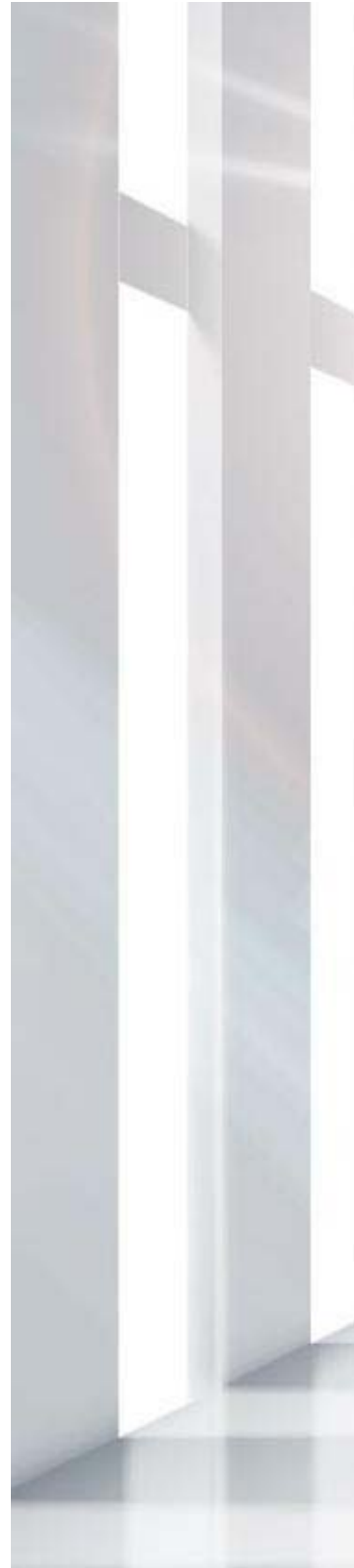



GARAGE



OUTDOOR

SOLAR FLOOD LIGHT

AMAZING IN PERFECT USE



SWL-40PRO
Equal to 600W
Incandescent Lamp



SWL-20PRO
Equal to 300W
Incandescent Lamp

Product Advantage

ALS Technology Guarantees 10 Continuous Working Nights
TCS Technology Ensures Longer Battery Lifespan

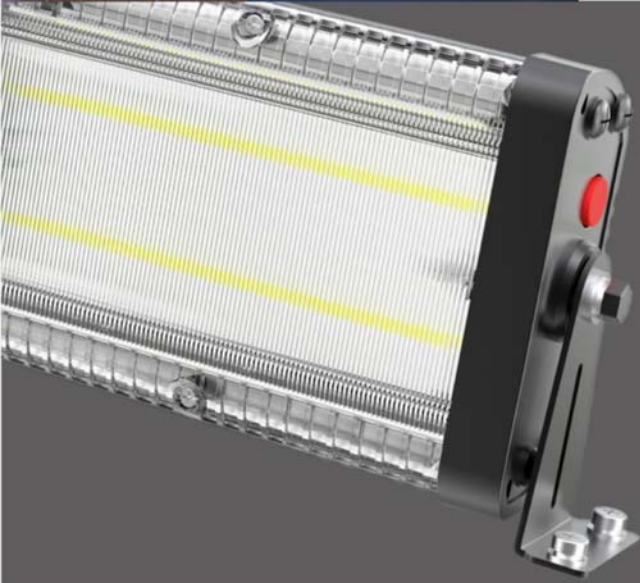

**Equal to
300W / 600W
Incandescent
Lamp**



SOLAR LIGHT I SPECIFICATIONS

Item :	SWL-20PRO	SWL-40PRO
Light Brightness	3000 Lumens	6000 Lumens
Solar panel		
Power	Monocrystalline , 14V/5W	Monocrystalline , 14V/10W
Li-ion battery		
Capacity	3.7V28.86WH 2.6AH/PC	3.7V57.72WH 2.6AH/PC
Charging/Discharging Temp	0~45°C / -20~60°C	0~45°C / -20~60°C
Charging Time	7.5H	7.5H
LED (OSRAM)	3030 30pcs	3030 60pcs
Color Temp	5700K , Ra 70+	5700K , Ra 70+
Efficiency	190lm/W	190lm/W
UV LED	-	-
Performance		
Lighting Time in Rainyday	>10 days	>10 days
Control Mode	Button Switch , ON/OFF Long Press 1.5s	
Lighting Mode(Remote Control)	M1 : 50% 1500LM(5H) + 10% 300LM Till dawn M2 : 30% 900LM(5H) + 10% 300LM Till dawn M3 : 20% 600LM Till dawn T: 3000LM 2Hrs	M1 : 50% 3000LM(5H) + 10% 600LM Till dawn M2 : 30% 1800LM(5H) + 10% 600LM Till dawn M3 : 20% 1200LM Till dawn T : 6000LM 2Hrs
Mode Indication	M1: Red / M2: Green / M3: Orange , T: Green light flashes	
Capacity Indication	Green : >70% Orange : 30%~70% Red 10%~30%	Green : >70% Orange : 30%~70% Red : 10%~30%
PIR	-	-
Core technology	ALS2.3	ALS2.3
Solar Panel Autoclean	-	-
IP/IK Class	IP65	IP65
Install Height	-	-

SWL-20PRO / 40 PPRO

Road Simulated Diagram



Illumination Curve

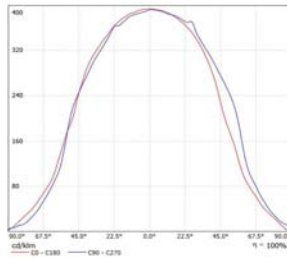

Luminance Distribution

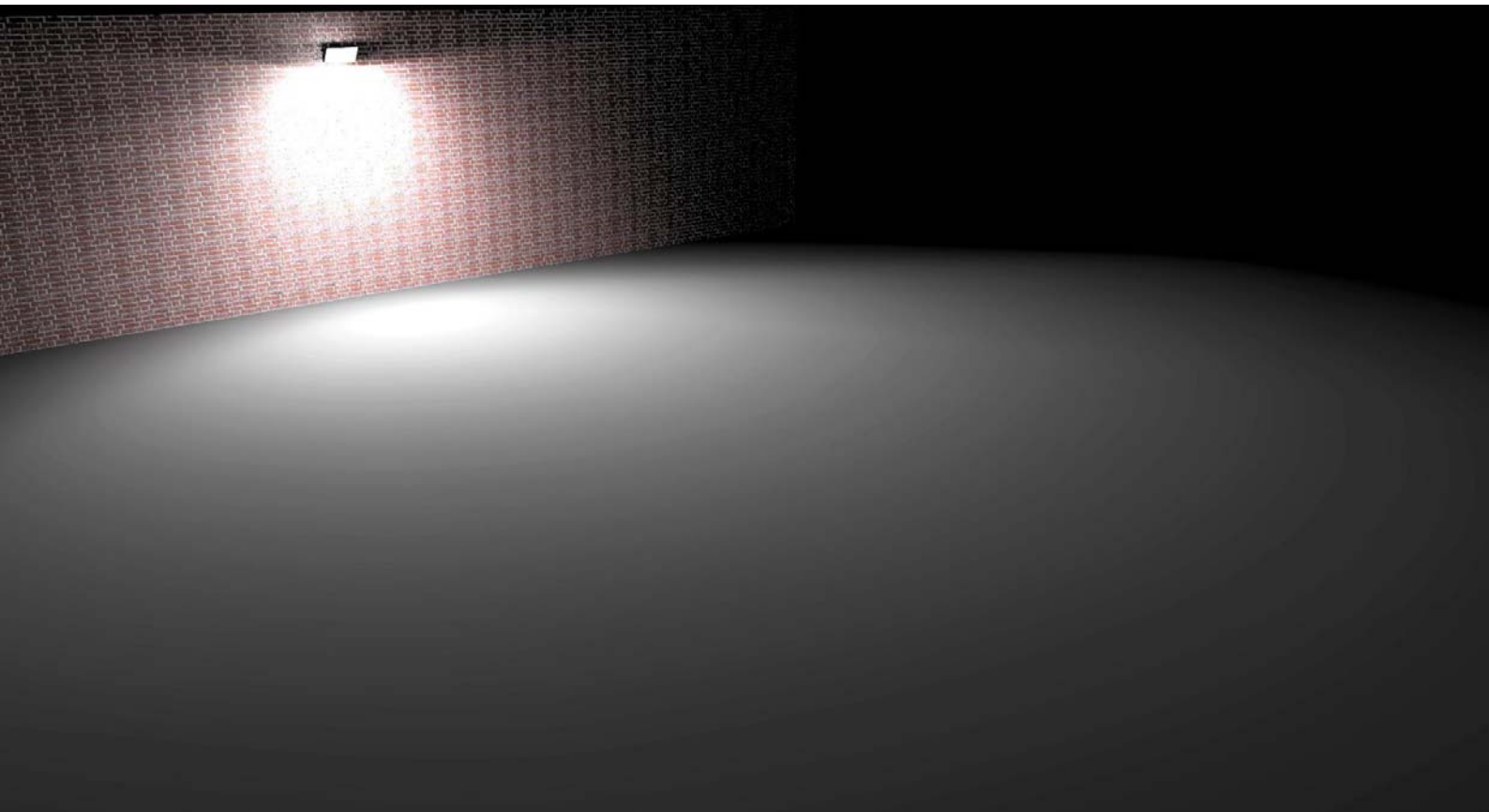
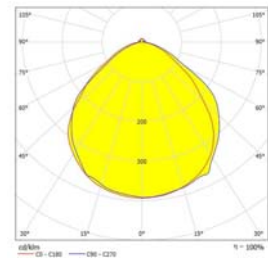

SOLAR LIGHT I DIMENTION FIGURE

SWL-20PRO

Solar Light

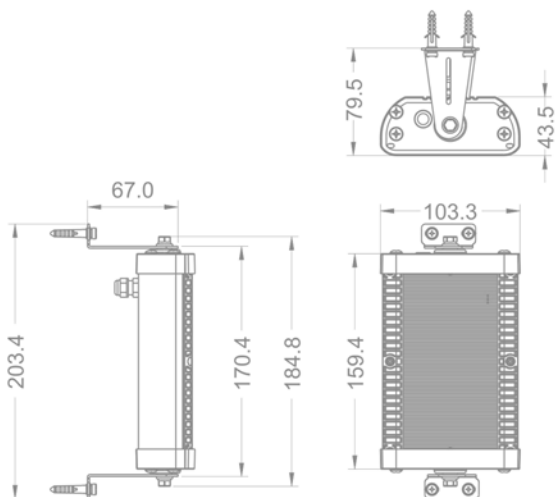

Solar Panel

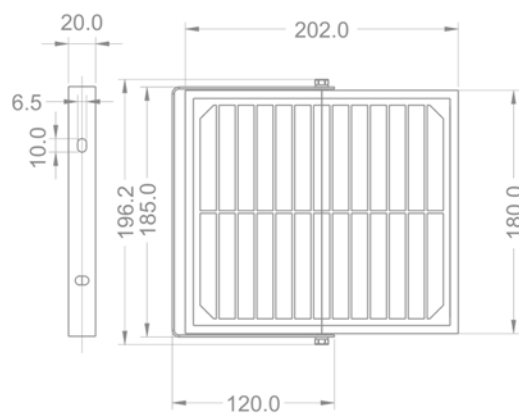

SWL-40PRO

Solar Light

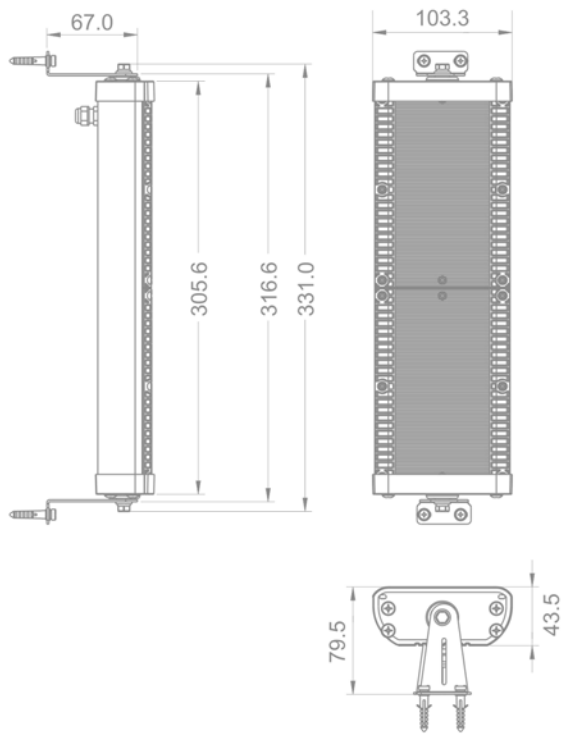

Solar Panel

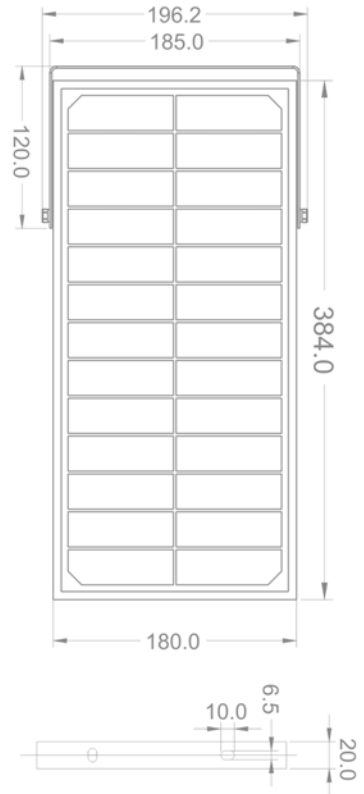

Detail Benefits

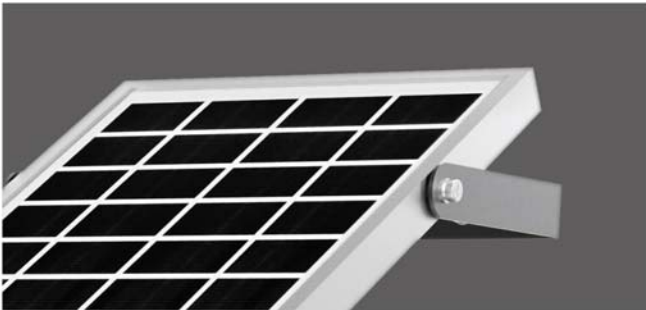

Monocrystalline >21%



High lumen LEDs 190lm/W



Switch
Bracket

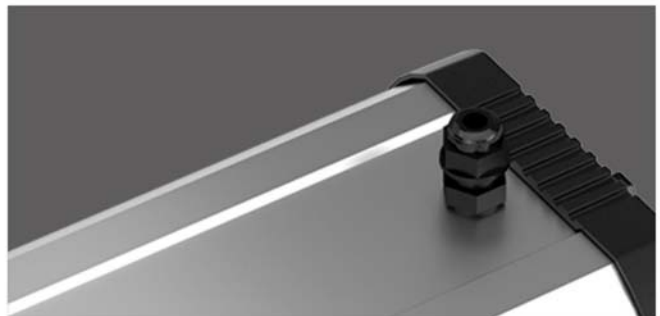

Back details



A Great Company should always pay the highest attention to the every detail design , and the craftsmanship spirit should be filled in the whole design process and mass production.

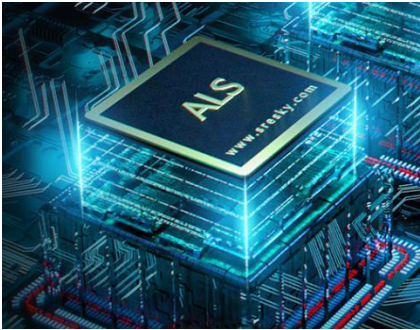

ADVANTAGE OF ALS

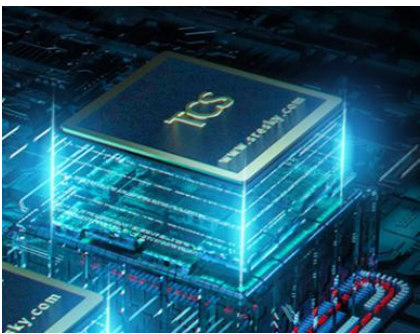
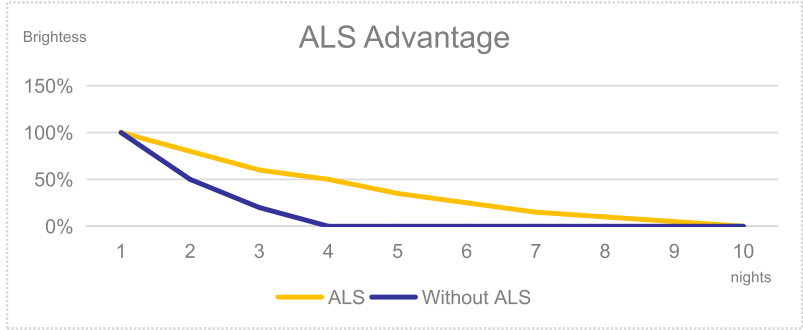

ADVANTAGE OF TCS

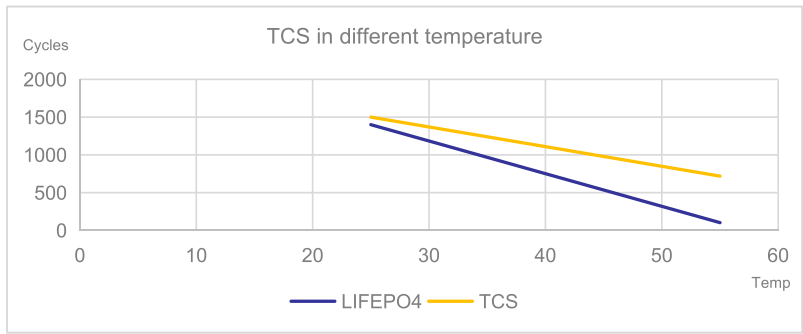

SOLAR LIGHT I PACKAGE DETAIL

PRODUCT LIST
 Solar Light : 1 PC
 Solar Panel : 1 PC
 Lamp body bracket : 1 PC
 Solar panel bracket : 1 PC
 Screw : 4 SET

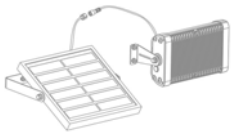

INNER BOX
 SIZE: 190*85*210mm
 1 PC / SET



1 LAYERS
 1 LAYER = 8 PCS

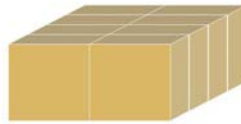

MASTER CARTON
 SIZE: 400*360*230mm
 8 PCS / CTN

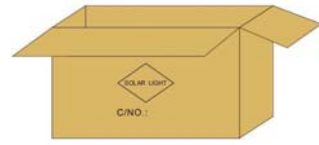

CARTON

LAYER NUMBER

COLOR BOX

PRODUCT LIST

STEP 1

STEP 2

STEP 3

STEP 4

MODEL NO.	PACKING METHOD	PCS/CTN	QTY(PCS)	CTN QTY	CARTON SIZE(MM)	N.W.(KG)	G.W.(KG)
SWL- 20PRO	INNER BOX	1	1	1	190*85*210	1.2	1.4
	CARTON	8	8	1	400*360*230	9.6	11.2

Net weight and gross weight are for reference only

SOLAR LIGHT I PACKAGE DETAIL

PRODUCT LIST
 Solar Light : 1 PC
 Solar Panel : 1 PC
 Lamp body bracket : 1 PC
 Solar panel bracket : 1 PC
 Screw : 4 SET

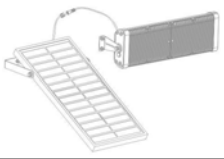

INNER BOX
 SIZE: 390*85*190mm
 1 PC / SET



1 LAYERS
 1 LAYER = 6 PCS



MASTER CARTON
 SIZE: 530*410*210mm
 6 PCS / CTN

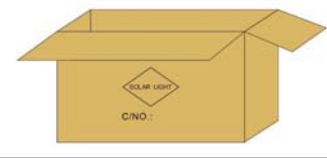

MODEL NO.	PACKING METHOD	PCS/CTN	QTY(PCS)	CTN QTY	CARTON SIZE(MM)	N.W.(KG)	G.W.(KG)
SWL- 40PRO	INNER BOX	1	1	1	390*85*190	2.2	2.6
	CARTON	6	6	1	530*410*210	13.2	15.6

Net weight and gross weight are for reference only

S / O / L / A / R / L / I / G / H / T

THANKS
VERY
MUCH

